

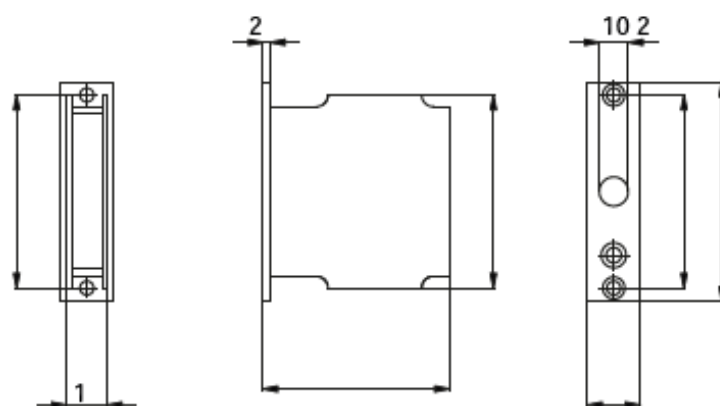



SCHEDA TECNICA

PARIDE



INCONTRO PER SERRATURE PORTE IN VETRO OMEC



COD.	F	mandate throws			
1247	18	-	0,12	-	50
1247/F16	16	-	0,12	-	50

WWW.FERRAMENTAPARIDE.IT