

MOTTURA NOVITA' 2017

SERIE 38.328

MADE
IN
ITALY



FERROGLIETTI
ad applicare
a cilindro europeo
Entrata chiave 30 mm
completo di mostrina interna

94.413
Piastra
di fissaggio

Viti M6 testa svasata
fissaggio Defender



94.922
Rinforzo
Defender

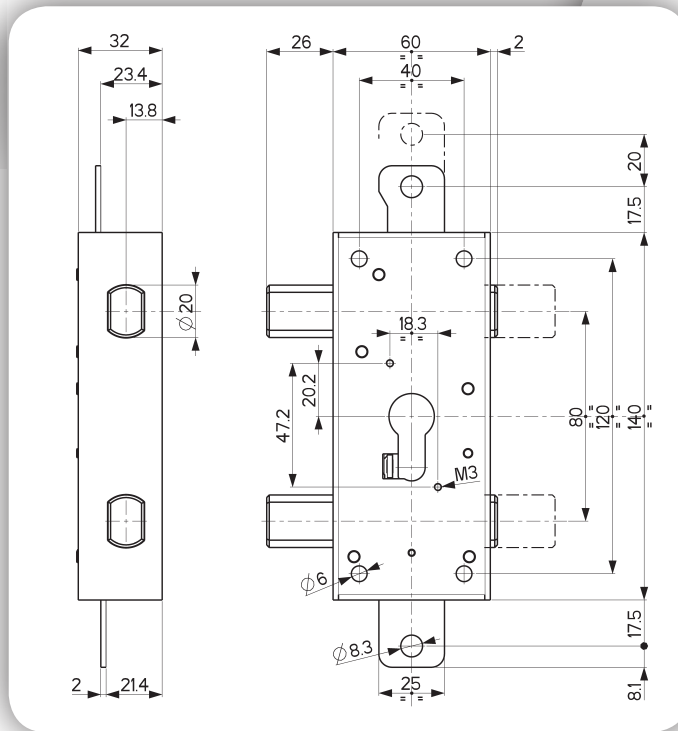

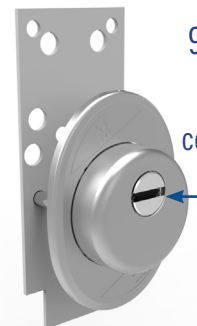

94.11625
Rinforzo
Defender



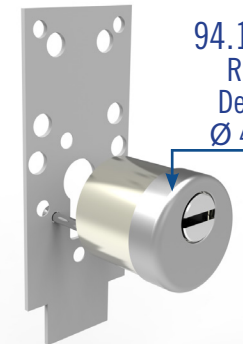
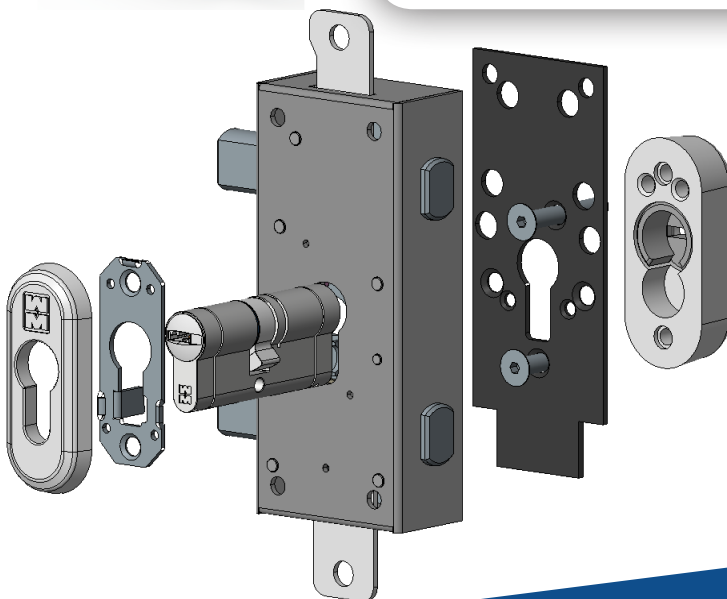

94.11725
Rinforzo
Defender
completo di
mostrina



94.11818
Rinforzo
Defender
Ø 42 mm

38.328..	Aste NON comprese Mostrina 95.421 inclusa		
Prezzo €			
71,67			
Ferroglietto triplice - Entrata chiave 30 mm Chiavistelli sezione mm 20x14 corsa mm 22 Corsa aste mm 20 L'articolo viene fornito destro e sinistro (specificare nell'ordine)			

Accessori

93.140N		94.413			
Finitura		Prezzo €		Finitura	Prezzo €
Nere		20,49		Zincata	3,36
Coppia aste Ø 18 mm registrabili da cm 152 a cm 270 totale n. 1 da 76 a 131 cm - n. 1 da 76 a 139 cm		Piastra di fissaggio per posa ferroglietto Dimensioni mm 135 x 54 x 2 N.B. Per il fissaggio del Defender alla piastra utilizzare esclusivamente viti a testa svasata.			
94.920		94.11818			
Finitura		Prezzo €		Finitura	Prezzo €
Nero		19,56		PVD oro	38,13
Rinforzo Defender® in ZAMA mm 32 x 75 x 18,5 per serie 32-37-38-47 protezione sull'entrata chiave: mm 6 Feritoia entrata chiave da mm. 3,5 o 5 (specificare nell'ordine)		Cromo satinato 32,01 Rinforzo Defender® Ø 42 per 32.590/690 - 38.328 Altezza mm 40. Interasse fori di fissaggio mm 25. Completo di n°2 viti speciali M4x20. Protezione su entrata chiave mm 6. Rondella cromata con feritoia entrata chiave mm 3,5 o 5 (specificare nell'ordine).			
94.922		95.420			
Finitura		Prezzo €		Finitura	Prezzo €
Nero		32,40		Nera	3,30
Rinforzo Defender® in ACCIAIO (53 HRC) mm 32 x 75 x 18,5 per serie 32-37-38-47 protezione sull'entrata chiave: mm 6 Feritoia entrata chiave da mm. 3,5 o 5 (specificare nell'ordine)		Mostrina in plastica esterna mm 32 x 75 x 8,5 completa di supporto metallico per serie 37, 38, 47 Conf. da 10 pezzi			
95.397..		95.397..			
Finitura		Prezzo €			
Anod.argento		6,76			
Anod.bronzo		3,27			
Ottone		2,90			
Cromata		3,47			
Cromo satinato		6,76			
Anod.nera		3,27			
PVD oro	9,43				
Mostrina mm 52 x 70 per cilindro europeo, completa di supporto in plastica Conf. da 10 pezzi					

Per tutte le tipologie di Defender vedere listino generale Mottura 2017.