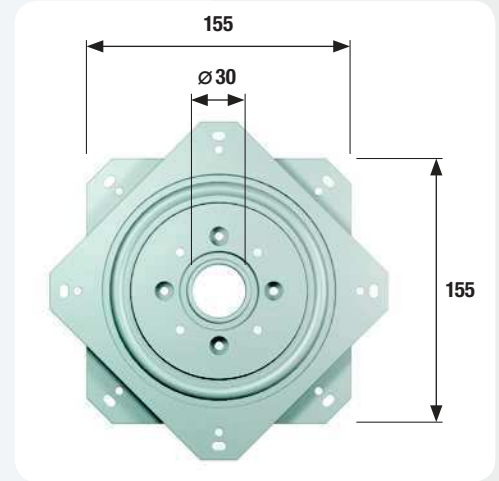
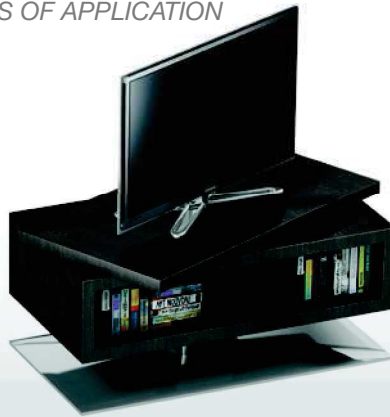
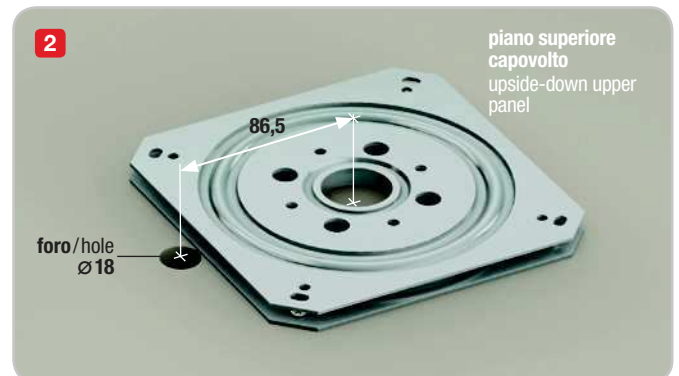

**1025**PORTATA MASSIMA  
CARRYING CAPACITY **150 kg****PIASTRA GIREVOLE 360° SU SFERE**  
360° BALL BEARING SWIVEL PLATE**ESEMPI DI APPLICAZIONE / EXAMPLES OF APPLICATION****ISTRUZIONI DI FISSAGGIO / ASSEMBLY INSTRUCTIONS**

- A** Fissare la piastra rotante nella parte inferiore del piano superiore.
- B** Praticare un foro da 18 mm sul piano superiore (vedi immagine 2).
- C** Appoggiare il piano superiore su quello inferiore con la piastra rotante a contatto del piano inferiore.
- D** Ruotare il piano superiore fino a far coincidere il foro da 18 mm con i fori per le viti sulla parte inferiore della piastra rotante.
- E** Fissare la piastra girevole al piano inferiore con un cacciavite attraverso il foro sul piano superiore.

- A** Fix the rotating plate underside the upper panel.
- B** Drill a 18 mm hole in the upper panel as per the picture 2.
- C** Place the upper panel on the lower panel with the rotating plate in contact with the lower panel.
- D** Rotate the upper panel to make the 18 mm hole correspond with the screw holes in the lower part of the rotating plate.
- E** Fix the rotating plate to the lower panel using a screwdriver through the hole in the upper panel.