

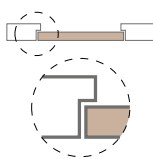

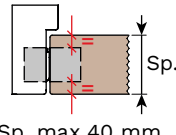

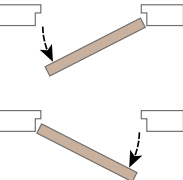

<p>MATERIALE</p> <p>Zama</p>	<p>PORTATA 120 kg (2 cerniere) 140 kg (3 cerniere)</p> 	<p>APPLICAZIONE Porta a filo-muro</p> 	<p>MISURA K</p>  <p>K-max 4 mm</p>										
<p>CERNIERA CENTRATA</p>  <p>Sp. max 40 mm</p>		<p>ANGOLO DI APERTURA 180°</p> 	<p>REGOLAZIONE 3D</p> 										
<p>FINITURA Full HD</p> 	<p>MATERIALE COVER Alluminio</p>  <p>Kit cover vite (optional)</p>	<p>ANTI EFFRAZIONE</p> 	<p>NUMERO FULCRI 7</p> 										
<p>Installabile in luoghi con elevate frequenze di apertura e chiusura</p>	<p>Product Quality</p>  <p>Multi-axis, concealed hinges EAD 020001-01-0405</p> <p>Reg.-N°: 9000283</p>		<p>Rif. report reference N° R27182-20130522</p> 										
<p>EN 1634-1</p>  <p>30 min.</p>	<table border="1"> <tr> <td rowspan="2">CE</td> <td>Krona Koblenz SpA Via Romero, 1 47853 Coriano</td> <td rowspan="2">18</td> </tr> <tr> <td>ETA-11/0477 DdP/DoP-Nr: 0021TA/CPR/2019-06-07</td> </tr> <tr> <td>0757-CPR-229EAD-9000283-1-3</td> <td colspan="2">HINGES DO NOT CONTAIN HARMFUL SUBSTANCES</td> </tr> <tr> <td colspan="3" style="text-align: center;">KUBI7 K7120</td> </tr> </table> <p>https://www.kronakoblenz.com/certificazioni/pdf/ce-certificate-k7120-k7080-koblenz.pdf</p>		CE	Krona Koblenz SpA Via Romero, 1 47853 Coriano	18	ETA-11/0477 DdP/DoP-Nr: 0021TA/CPR/2019-06-07	0757-CPR-229EAD-9000283-1-3	HINGES DO NOT CONTAIN HARMFUL SUBSTANCES		KUBI7 K7120			<p>EN 1670</p> <p>Resistenza alla corrosione</p> <p>240 ore</p>
CE	Krona Koblenz SpA Via Romero, 1 47853 Coriano	18											
	ETA-11/0477 DdP/DoP-Nr: 0021TA/CPR/2019-06-07												
0757-CPR-229EAD-9000283-1-3	HINGES DO NOT CONTAIN HARMFUL SUBSTANCES												
KUBI7 K7120													
<p>MADE IN ITALY</p> 													

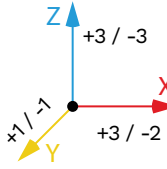
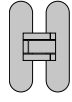

Finiture

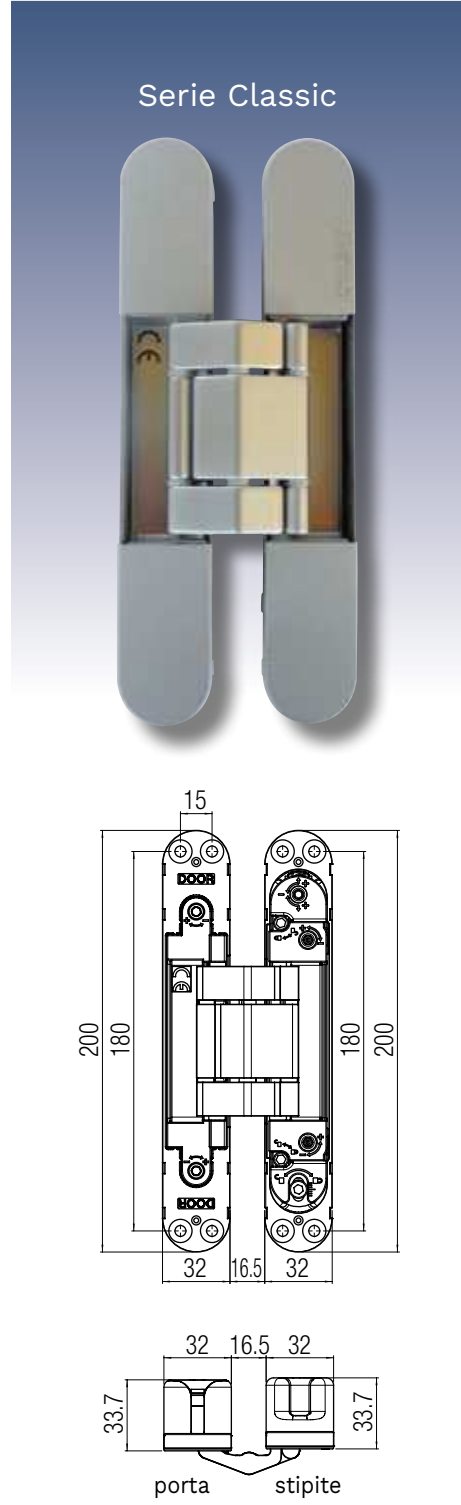
Colore	Codice art.
	Cromo satinato K 7120 CS HD
	Nichel satinato K 7120 NS HD

Per finiture differenti contatta Krona Koblenz per fattibilità



Info prodotto:



Tabella di portata (vedi pagina 12 per la guida alla lettura)

Interasse cerniere (mm)**	K7120 - 120 Kg - N° 2 cerniere											
	120	120	120	120	120	120	120	120	120	120	115	111
2000	120	120	120	120	120	120	120	120	120	120	115	111
1950	120	120	120	120	120	120	120	120	120	120	117	113
1900	120	120	120	120	120	120	120	120	120	119	114	110
1850	120	120	120	120	120	120	120	120	120	116	111	107
1800	120	120	120	120	120	120	120	118	113	108	104	100
1750	120	120	120	120	120	120	115	110	105	101	97	94
1700	120	120	120	120	120	117	112	107	102	98	94	90
1650	120	120	120	120	119	113	108	104	99	95	92	89
1600	120	120	120	120	115	110	105	100	96	92	89	86
1550	120	120	120	118	112	107	102	97	93	89	86	83
1500	120	120	120	114	108	103	98	94	90	87	84	81
1450	120	120	116	110	105	100	95	91	87	84	81	78
1540	120											
	926	700	800	900	950	1000	1050	1100	1150	1200	1250	1300
	Larghezza pannello (mm)**											

Interasse cerniere (mm)**	K7120 - 140 Kg - N° 3 cerniere											
	140	140	140	140	140	139	132	127	121	117	112	
2000	140	140	140	140	140	139	132	127	121	117	112	
1950	140	140	140	140	140	135	129	123	118	114	109	
1900	140	140	140	140	138	132	126	120	115	111	106	
1850	140	140	140	140	135	128	122	117	112	108	104	
1800	140	140	140	138	131	125	119	114	109	105	101	
1750	140	140	140	134	127	121	116	111	106	102	98	
1700	140	140	138	130	124	118	113	108	103	99	95	
1650	140	140	134	126	120	114	109	104	100	96	92	
1600	140	140	129	123	117	111	106	101	97	93	90	
1550	140	140	125	119	113	108	103	98	94	90	87	
1500	140	137	121	115	109	104	99	95	91	87	84	
1450	140	132	117	111	106	101	96	92	88	84	81	
1730	140											
	900	700	800	900	950	1000	1050	1100	1150	1200	1250	1300
	Larghezza pannello (mm)**											

Specifiche di test:

- 2 cerniere: Interasse cerniere 1540 mm - Larghezza pannello 926 mm - Angolo di apertura 0°-90°.
- 3 cerniere: Interasse cerniere 1730 mm - Larghezza pannello 900 mm - Angolo di apertura 0°-90°.

**Con pannello di dimensioni ed angolo max di apertura differenti dalla configurazione testata e/o con l'applicazione congiunta di altri dispositivi quali, ad esempio, chiudiporta/paracolpi/maniglione antipanico/guarnizione a ghigliottina/ecc. fare riferimento agli "Esempi di installazione". Si ricorda che i test per queste configurazioni sono a cura e sotto la responsabilità del cliente. Specifichiamo che le combinazioni e i valori di portata sono frutto di interpolazione e non di test reale, che rimane a cura e sotto la responsabilità del cliente.

Quote applicazione standard

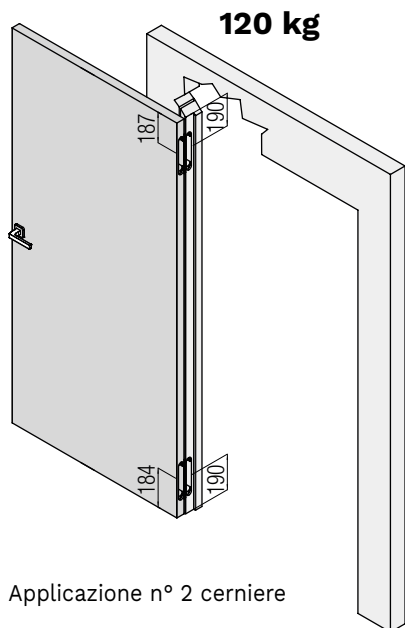

Applicazione n° 2 cerniere

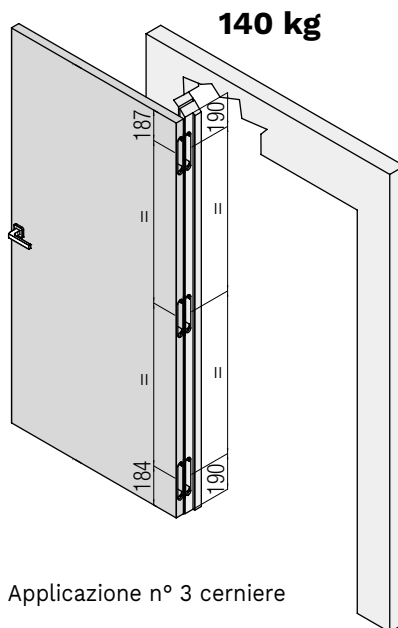

Applicazione n° 3 cerniere

Fresata porta/stipite

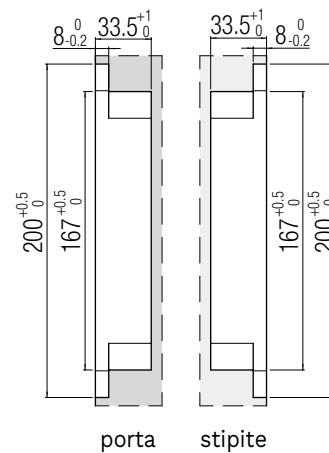

porta stipite

Installazione cerniera centrata

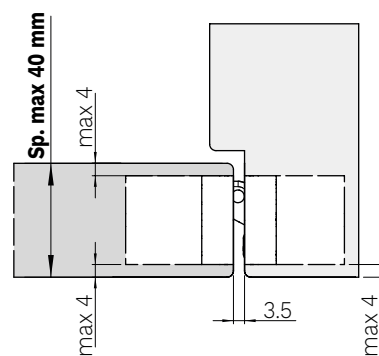

Installazione cerniera NON centrata

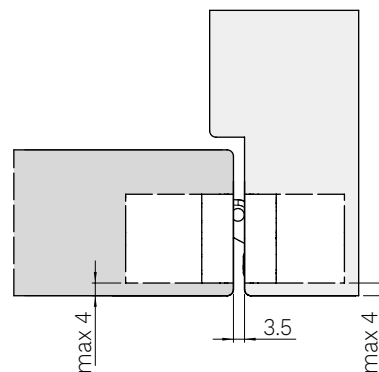

⚠ Viti per fissaggio incluse

Il fissaggio della cerniera è garantito utilizzando le **viti di fissaggio** indicate nelle istruzioni di montaggio della cerniera.