

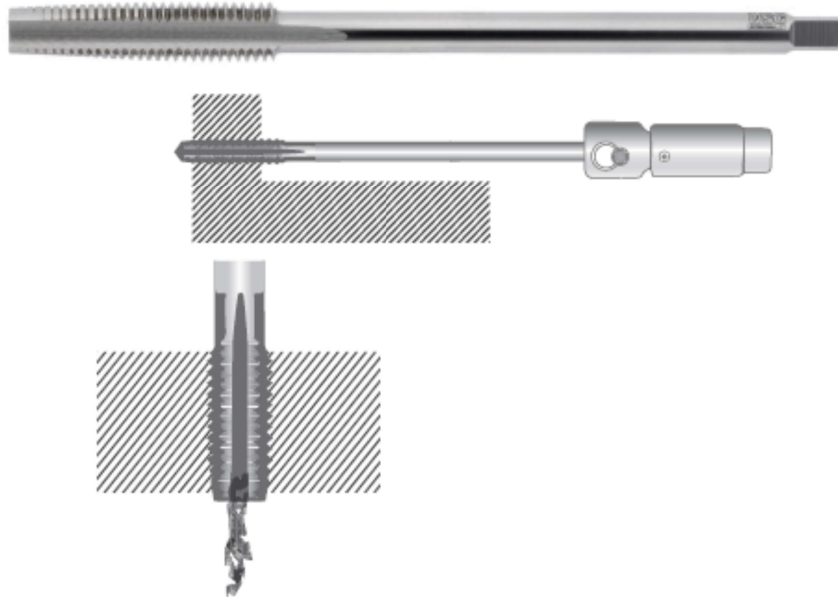







SCHEDA TECNICA



MASCHIO A MACCHINA GAMBO LUNGO PASSANTE 6070 WSG

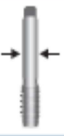

| <br>M | <br>mm | <br>mm | <br>mm | <br>mm | <br>h9 mm | <br>h12 mm |
|--|---|---|---|--|--|---|
| 3  | 2,5   | 0,5   | 70  | 22   | 2,2  | –   |
| 3,5  | 2,9   | 0,6   | 80  | 25   | 2,5  | 2,1   |
| 4  | 3,3   | 0,7   | 90  | 25   | 2,8  | 2,1   |
| 5  | 4,2   | 0,8   | 100   | 28   | 3,5  | 2,7   |
| 6  | 5   | 1   | 110   | 32   | 4,5  | 3,4   |
| 8  | 6,8   | 1,25  | 125   | 40   | 6  | 4,9   |
| 10   | 8,5   | 1,5   | 140   | 45   | 7  | 5,5   |
| 12   | 10,2  | 1,75  | 180   | 50   | 9  | 7   |
| 14   | 12  | 2   | 200   | 56   | 11   | 9   |
| 16   | 14  | 2   | 200   | 63   | 12   | 9   |
| 18   | 15,5  | 2,5   | 220   | 63   | 14   | 11  |
| 20   | 17,5  | 2,5   | 250   | 70   | 16   | 12  |
| 22   | 19,5  | 2,5   | 280   | 80   | 18   | 14,5  |
| 24   | 21  | 3   | 280   | 80   | 18   | 14,5  |
| 27   | 24  | 3   | 315   | 90   | 20   | 16  |
| 30   | 26,5  | 3,5   | 315   | 100  | 22   | 18  |
| 33   | 29,5  | 3,5   | 355   | 110  | 25   | 20  |