

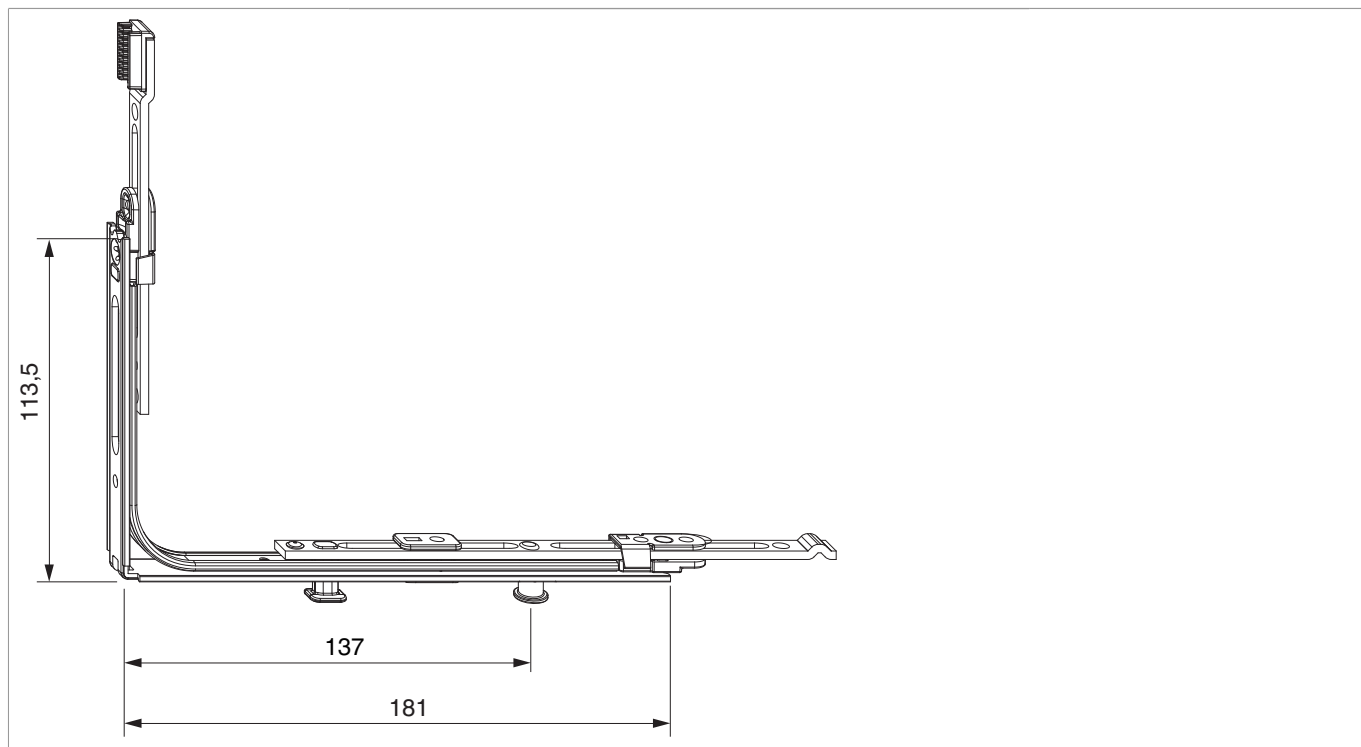



222206 - Movimento angolare Multi Matic prolungabile orizzontalmente per cremonese variabile con 1 fungo LBB 320-1.800 argento

Disegni tecnici



		B	H				Nº
argento	per cremonese variabile prolungabile orizzontalmente con 1 fungo	181	113,5	320 - 1.800	470 - 2.800	50	222206 ¹⁾

¹⁾ In combinazione con angolo cerniera utilizzabile a partire da una LBB 365 mm e non prima.

Tabella posizionamento viti



Nº		1	2	3		4	5
222206	3	106,5	174	189	2	106,5	121,5

Tabella punti di chiusura

Nº		Z1		Z2
222206	1	137	0	

Posizionamento scontro

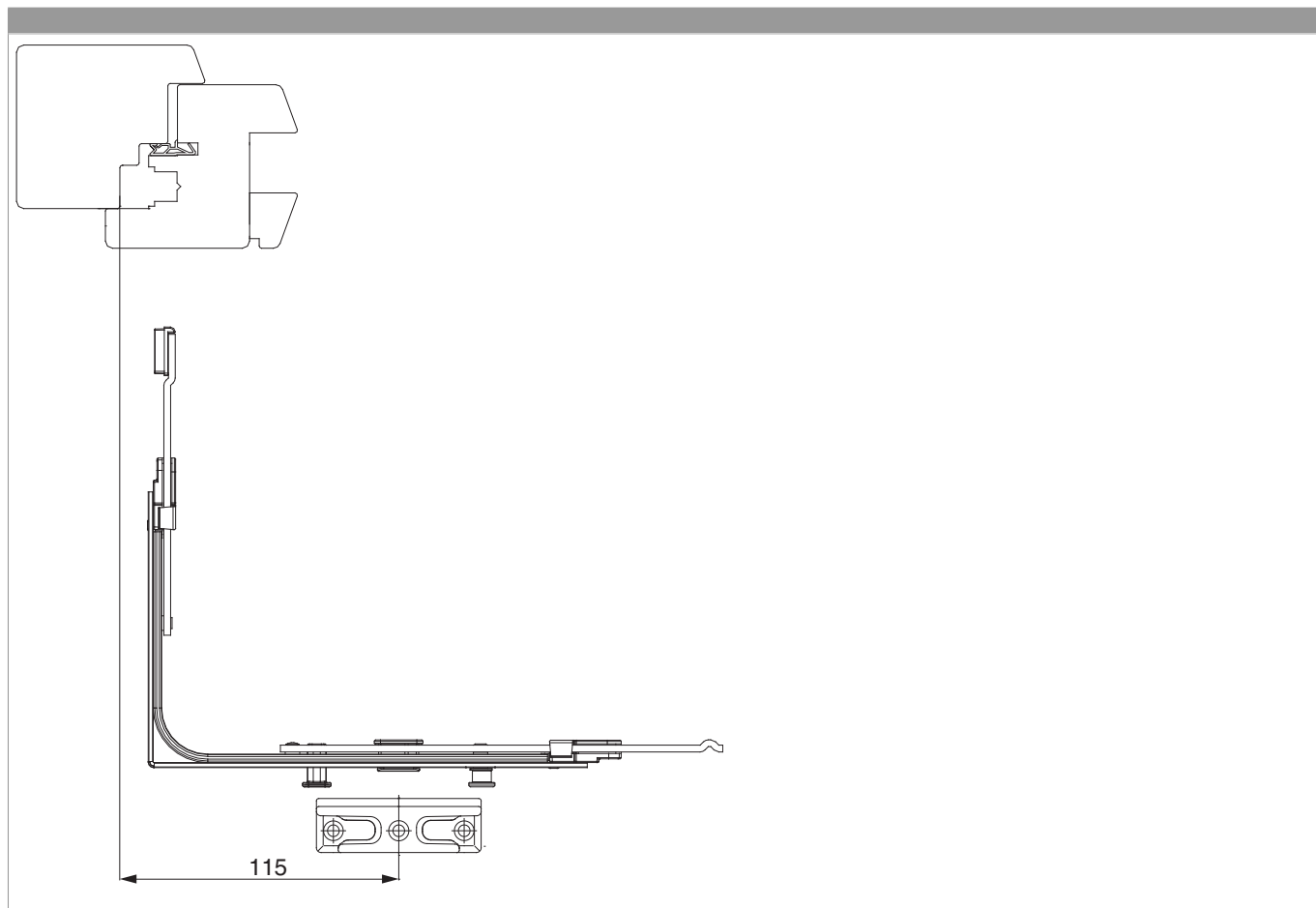

Regolazione pressione

Fungo e nottolino

