

SCHEDA TECNICA

 **PARIDE**

fondata nel 1920

MANIGLIA SUPIASTRA 8605 OMAD

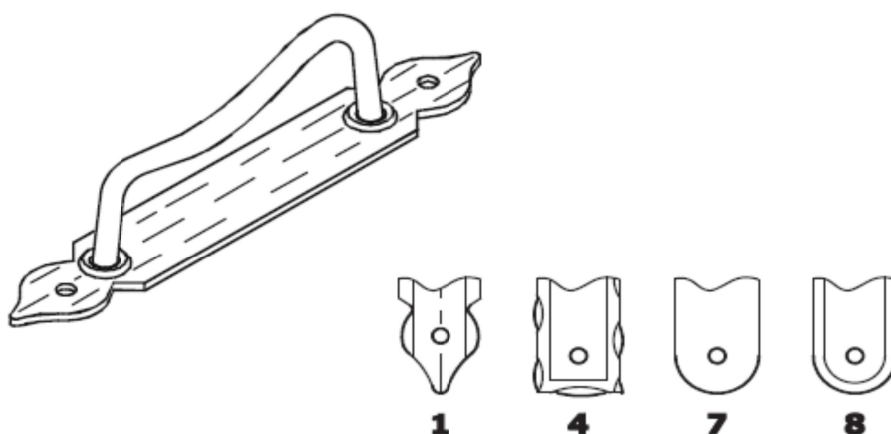

Articolo	L	Pz./conf.	Cataforesi + vern. nero
160500000#	190	25	
460500000#	190	25	
760500000#	190	25	
860500000#	190	25	

WWW.FERRAMENTAPARIDE.IT