

SCHEDA TECNICA

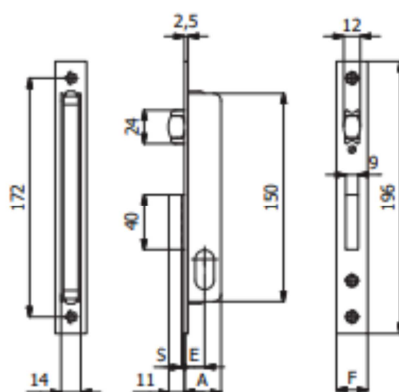

SERRATURA MONTANTE-CATENACCIO RULLO REGOLABILE OMEC



COD.	E	F	A	S	mandate throws			
340	15	16	26	2	1	0,27	1	10
340/F22	15	22	26	2	1	0,29	1	10
320	20	16	31	2	1	0,29	1	10
320/F22	20	22	31	2	1	0,31	1	10