

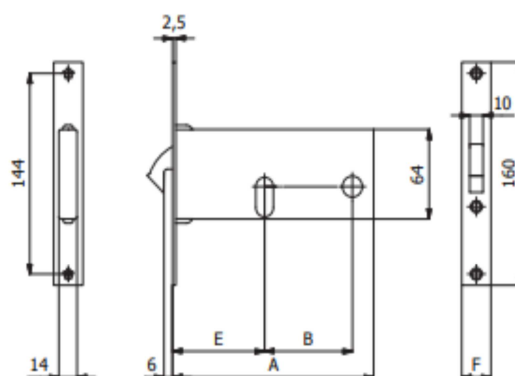

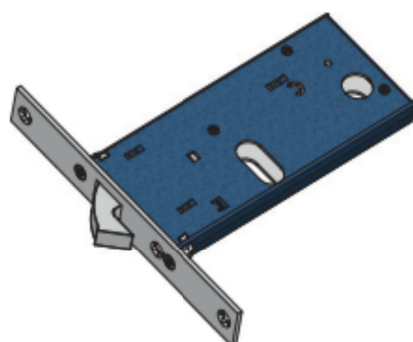

SCHEDA TECNICA

# PARIDE



SERRATURA PER FASCE CON GANCIO OMEC



COD.	E	F	A	B	mandate throws			
386	60	16	133	47	1	0,38	1	10
386/F22	60	22	133	47	1	0,40	1	10
786	70	16	153	67	1	0,41	1	10
786/F22	70	22	153	67	1	0,43	1	10

[WWW.FERRAMENTAPARIDE.IT](http://WWW.FERRAMENTAPARIDE.IT)